

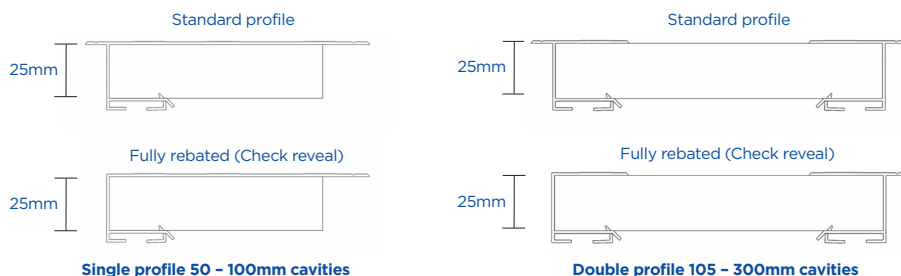

Thermo-loc FR 30 minute fire rated cavity closers

Fire rated closers for eliminating damp and 'cold bridging' around doors, windows and sills



Use

- To close the cavity at external doors, window jambs and sills
- To provide thermal insulation and prevent 'cold bridging'
- To provide a DPC at external doors, window jambs or sills
- 30 minutes fire rating and minimum 15 minutes insulation
- Suitable for cavities up to 300mm
- Suitable for timber and masonry walls

Features and benefits

- Provides an effective DPC and thermal barrier between frame, inner and outer wall leaf
- Thermal conductivity of 0.036W/mK
- Exceeds the minimum thermal resistance path of 0.45m²K/W stipulated in Robust Details 'limited thermal bridging and air leakage'
- Rigid profile extrusion allows both first and second fix
- Suitable for all frame and sill positions (see fig.1)
- Durable and resistant to decay
- Insulation option to suit your requirements both thermal and fire rated
- Global warming potential of zero
- Ozone depletion potential of zero
- Available in fully rebated (check reveal) profiles

Quality

- Independently tested by Exova Warrington Fire
- LABC Registered Detail
- BBA Approved
- Satisfies NHBC Standards
- Manufactured to BS EN ISO 9001 and BS EN ISO 14001
- Complies with Building Regulation Approved Documents C, B, L1 & L2
- Complies with Robust Details 'limited thermal bridging and air leakage'
- Complies with the Scottish Building Standards 'Technical handbook'
- Satisfies BRE document 'Thermal insulation: avoiding risks'
- Meets all relevant British Standards

Material and colour choice

- Rigid profile extruded in white UPVC
- Supplied in 2.4 metre lengths
- Standard cavity options available 50mm - 300mm
- Rockfibre mineral wool (FR) insulation 0.036W/mk

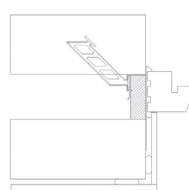

Flush jamb

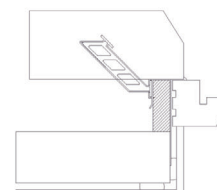

Fully rebated (check reveal)

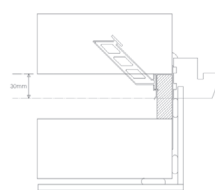

Staggered jamb

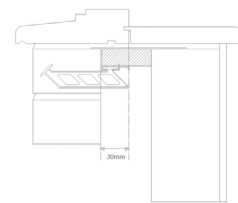

Sill detail

Fig.1

Installation advice

- Can be used in both first and second fix applications
- Cut the cavity closer into required lengths allowing the jamb section to overlap the sill section and to butt the underside of the lintel
- In first fix application the cavity closer should be nailed to the jamb/sill of the door or window frame and the whole assembly built in as work proceeds. Alternatively the closer can be built in sections using fixing ties as work proceeds or pre built to act as an opening former by using a timber brace (see fig.2)
- For second fix applications, the cavity closer is pushed into the open cavity after building work is complete. The compressible nature of the exposed insulation material is used to create a friction fit in the cavity, or alternatively the insulation can be trimmed using a sharp knife
- Joining 'off cut' sections should not be carried out for the FR range



Thermo-loc FR 30 minute fire rated cavity closers

Fire rated closers for eliminating damp and 'cold bridging' around doors, windows and sills

Page 2 of 2

Cavity closers for fully rebated/ check reveals also available

How to order

- Establish the cavity width and select the correct cavity closer width, or the next size up to ensure the cavity can be closed
- In jamb and sill applications, first estimate the total length of cavity closer required, then order the correct number of individual 2.4 metre lengths so no joint pieces
- Fixing ties are available for secure fixing if required (particular attention around door openings). Allow for ties fitted at 450mm centres

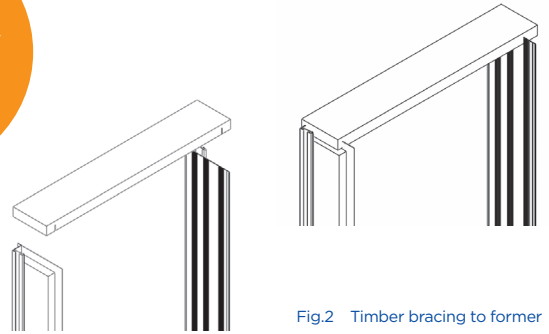

Fig.2 Timber bracing to former

Bill of quantity

n55Plus

F30 Accessories/sundry items for brick/block/stone walling

Clause

180 CAVITY CLOSURES FOR CLOSING AROUND WINDOW & DOOR OPENINGS

To extend not less than 150mm beyond ends of lintels/bridgings.

• Manufacturer: **Timloc Building Products, Timloc House, Ozone Park, Howden, East Yorkshire, DN14 7SD. Tel: 01405 765567,**

Fax: 01405 720479. Web: www.timloc.co.uk

• Reference:.....eg. CC2.4 FR/75 (Thermo-loc Cavity Closer, Fire Rated, 2.4m, 75mm cavity)

• Accessories: Fixing ties available, 6 No. per 2.4m cavity closer.

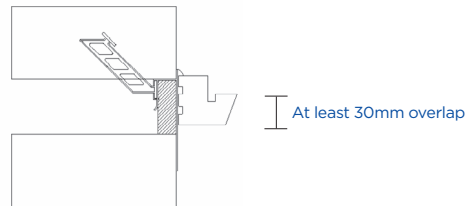

Fig.3

Product codes

Thermo-loc FR cavity closers

Description	Cavity width	Length	Product code
Thermo-loc FR	50mm	2.4m	CC2.4 FR/50
Thermo-loc FR	65mm	2.4m	CC2.4 FR/65
Thermo-loc FR	75mm	2.4m	CC2.4 FR/75
Thermo-loc FR	90mm	2.4m	CC2.4 FR/90
Thermo-loc FR	100mm	2.4m	CC2.4 FR/100
Thermo-loc FR	125mm	2.4m	CC2.4FR/125
Thermo-loc FR	150mm	2.4m	CC2.4FR/150
Fixing tie Pack of 30)	-	-	CCFIX30
Fixing tie Pack of 100)	-	-	CCFIX100

NB. Non standard cavity size to special order

Insulation type

Rockfibre mineral wool (FR)

Thermal conductivity

0.036W/mK

Technical considerations

- BRE Document 'Thermal insulation: avoiding risks' and Robust Details stipulate: "When a window or door frame is set back behind the inner face of a dense outer masonry leaf, it should overlap an insulated closer by a minimum of 30mm for BRE exposure zones Sheltered to Severe; but fully rebated (check reveals) for zones Very Severe" (see fig.3)
- With reference to insulation, the products in this range do not use, contain or produce Urea Formaldehyde, CFC's or indeed any of the so called soft CFC's, ie. HCFC's & HFA's. They conform to the Montreal Protocol and have an ozone depletion potential of zero and global warming potential of zero.