



Technical information & installation advice

Horizontal cavity trays

Horizontal cavity trays are those which run horizontally within the wall and are appropriate in such situations as:

- At the abutment of a flat roof with a cavity wall
- At the abutment of a lean-to roof with a cavity wall
- Above door or window openings
- Above the edge of a concrete slab or ring beam
- Above airbricks or meter boxes
- Above ducts, pipes or cavity liners which pass through an external wall.

When specifying or installing horizontal cavity trays it is important to consider the following recommendations:

- Allow for the run of cavity trays to be slightly longer than the overall width of the roof abutment or area requiring cavity tray protection. A minimum projection of 150mm at each end of the cavity tray run is recommended
- When installing horizontal cavity trays over a roof abutment the line of the cavity trays should be approximately 150mm above the top of the finished roof line. This distance will vary slightly depending on how the roof line falls with the coursing on the face of the wall, however, it must be a minimum of 75mm above the top of the finished roof line. The exposed area between the base of the cavity tray and the roof covering must then be fully protected by an appropriate external flashing (see lead flashing section)

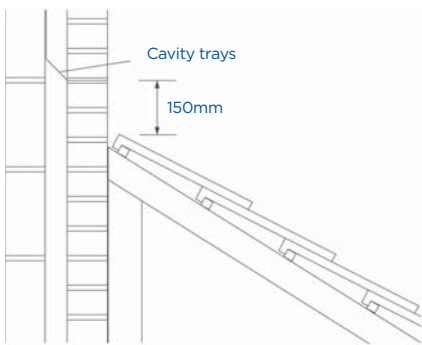

- **Cavity trays must always be bedded onto fresh mortar, never dry bedded.** The brickwork which is then laid over the cavity trays must also be bedded onto fresh mortar with the result that the base of the cavity tray is positioned approximately half way through the mortar joint
- The cavity area must be kept clean and free from mortar droppings and debris. A build-up of mortar within the cavity tray could seriously affect the cavity trays performance
- A stopend must always be fitted at the start and finish of a run of cavity trays. The Inter-loc range has integrated stop ends, but the System 2000 requires separate stop end units. These stopends fit by means of a pre-applied butyl mastic seal. In order for this to seal correctly it is essential that the release paper is removed, the joint area is clean and dry and pressure is applied along the full length of the joint area once the stopend and cavity tray are brought together
- It will usually be necessary to link a number of cavity tray sections in order to form a continuous cavity tray run of the required length. The Inter-loc range has an integrated capping system for joining units whereas System 2000 has cavity tray sections that link by means of a lapped joint with a pre-applied butyl mastic seal. In order for this to seal correctly it is essential that the release

paper is removed, the joint area is clean and dry and pressure is applied along the full length of the joint area once the two sections of cavity tray are brought together. If there is any doubt about the integrity of any joint do not proceed with further installation until the joint is made good - apply additional sealant if necessary

- Weep holes must be provided in the face of the wall along the run of the cavity trays. These are essential as without weep holes the water collected by the cavity trays cannot discharge from the wall. Weep holes can be formed by simply installing a Timloc purpose-made plastic wall weep unit (product 1143/TW1) of the type shown under our cavity wall weep section. Weep holes should be spaced every 450mm along the run of cavity trays over lintels and 900mm over horizontal cavity trays. Ensure one weep per Inter-loc tray
- If it is necessary for the cavity trays to turn around a corner on the building always use a purpose made one piece corner unit. Never try to site fabricate this critical detail
- High quality workmanship, cleanliness and attention to detail are essential with all cavity tray installations. If there is any doubt regarding the correct method of installation assistance must be sought from the Timloc Technical Services Department or Timloc's Regional Technical Adviser.

Stepped cavity trays

Stepped cavity trays are those which step up the wall in order to follow the abutment of a pitched roof with a cavity wall.

When specifying or installing stepped cavity trays it is important to consider the following recommendations:

- Ensure that the run of cavity trays protects the abutment fully from eaves to ridge. The first (lowest) cavity tray should ideally project just beyond the eaves line of the roof. Further cavity trays must then be installed on every course for the full length of the abutting roof slope
- The cavity trays should be positioned on a line parallel to and 75mm above the top of the finished roof line. In order to set out the cavity trays accurately it is essential that some sort of guide line is set up for the bricklayer to work to. Allowance must be made for the thickness of the roof timbers, tiles, battens, etc. so that the line represents the top of the **finished** roof line. This is most easily achieved if an appropriate roof truss is available which can be set up in the correct position and used to secure the guide line

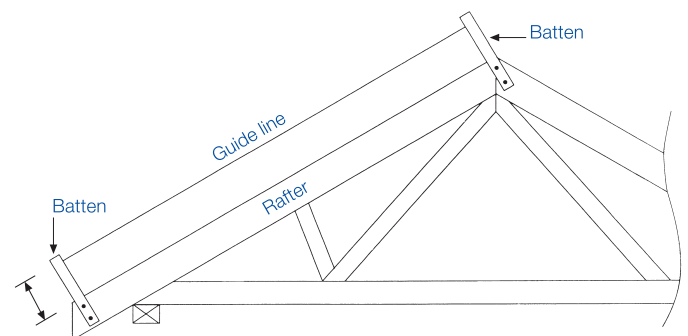

75mm + thickness of roof covering

- **Cavity trays must always be bedded onto fresh mortar, never dry bedded.** The brickwork which is then laid over the cavity trays must also be bedded onto fresh mortar with the result that the base of the cavity tray is positioned approximately half way through the mortar joint

Page 1 of 5 see next page



Technical information & installation advice

Page 2 of 5

- **The cavity area must be kept clean and free from mortar droppings and debris.** A build-up of mortar within the cavity tray could seriously affect the cavity trays performance
- The first cavity tray installed at the lowest point on the abutment must always be a starter tray of some description. This type of tray is closed at both ends and collects the water which has been gathered by the rest of the cavity tray system. If the side wall of the abutting building lies within the width of the main building then a stopend starter tray is used. If the side wall of the abutting building is in line with, or steps out beyond, the side wall of the main building then a corner starter tray is used
- The main body of the cavity tray run is made up of a series of intermediate trays with one positioned on every course for the full length of the abutment. Intermediate trays have one closed end and one open end which results in them being either left or right handed. It is very important to ensure that the correct hand is used to suit the direction of roof slope. The closed end of the intermediate tray must be positioned closest to the roof line with the open end pointing away from the roof. The corner of the closed end of the tray should be positioned on the guide line, 75mm above the finished roof line
- Each cavity tray should overlap the next. If it is found that there is little or no overlap between the cavity trays, when they are correctly positioned on the guide line, then something is wrong - check with Timloc Technical Department
- Weep holes must be provided in the face of the wall. These are essential as without weep holes the water collected by the cavity trays cannot discharge from the wall. In sheltered areas where the cavity trays are not required to cope with serious water penetration for long periods then a single weep hole is satisfactory, positioned at the bottom of the run in the stopend starter tray or corner starter tray. However, in more exposed locations, or if it is known that particularly porous facing brickwork is being used, then additional weep holes must be provided at other locations along the run of cavity trays - please consult Timloc Technical Services Department. Weep holes can be formed by leaving perp. joints open and free from mortar or by installing purpose made plastic wall weep units

- High quality workmanship, cleanliness and attention to detail are essential with all cavity tray installations. If there is any doubt regarding the correct method of installation assistance must be sought from the Timloc Technical Services Department or Timloc's Regional Technical Adviser.

Cavity widths

There are a wide range of cavity widths used in UK building practice.

The standard Timloc Everdry cavity trays are adjustable for a large cavity range. Fixed options are available in three cavity width sizes of 50mm, 75mm and 100mm, which will satisfactorily cover the vast majority of applications.

In the case of our fixed cavity range it is not necessary for the tray to exactly match the wall cavity width. Please consider the following points:

- It is important to ensure that the cavity tray is not too wide to suit the wall cavity, otherwise it will be difficult or impossible to fit, e.g. do not try to fit a 100mm cavity width tray into an 80mm wall cavity
- If the actual wall cavity width falls between the standard Timloc sizes then the cavity width should be rounded down, e.g. for a 65mm wall cavity width use the 50mm cavity width tray
- The cavity tray does not need to fully fill the wall cavity. As long as the tray projects more than half way across the wall cavity then it will function correctly

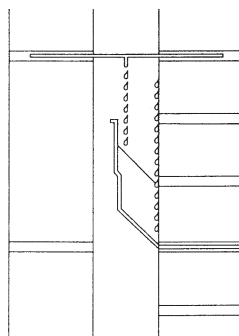

Below gives a general impression of how a complete cavity tray system should be set out.

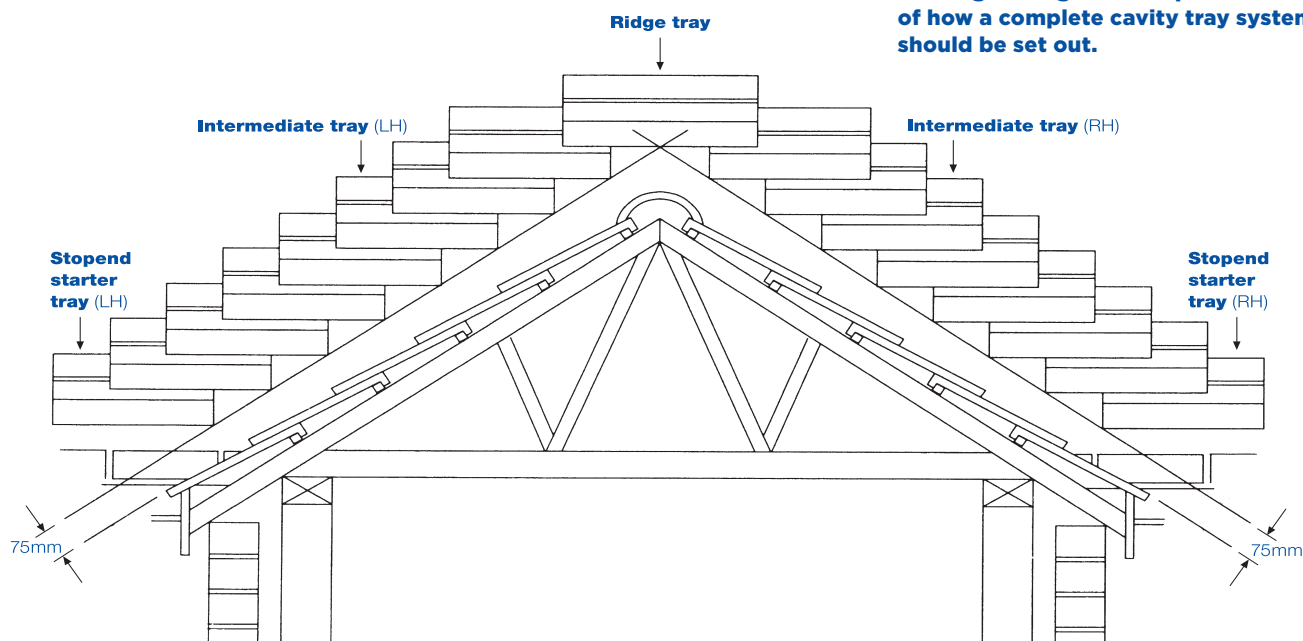



Technical information & installation advice

Page 3 of 5

Cavity insulation

The use of cavity insulation can have an effect on the cavity trays, please consider the following:

- Partial fill cavity insulation has the effect of reducing the clear cavity width within the wall. If the remaining clear cavity in front of the insulation is at least 50mm wide then it is best to size the cavity trays according to this clear cavity width. This will avoid having to cut or remove insulation material unnecessarily.

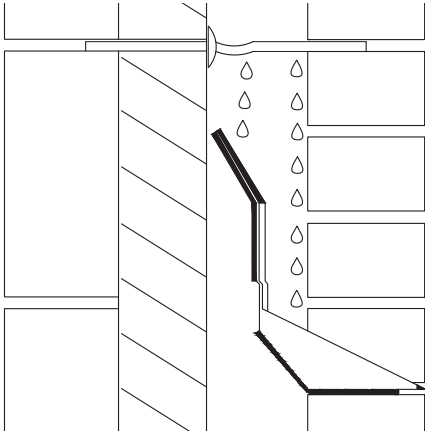

- Full fill cavity insulation generally leaves no space for the cavity trays to be fitted. The insulation must be cut in order to allow the cavity trays to be fitted to form a localised clear cavity of no less than 50mm. This will prevent cold bridging while allowing installation behind the cavity tray. Cavity tray selection will be based on the clear cavity provided.

Important note - It is essential that full fill cavity insulation systems use materials which are impervious to water penetration. Any insulation materials which could absorb or transmit water could allow water to track across the cavity or past the cavity trays and would seriously impair the performance of the cavity trays

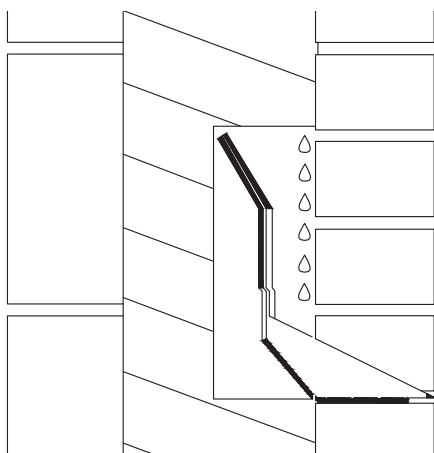

- Post installed pumped or blown insulation systems are not recommended for use in areas containing cavity trays. The lack of monitoring or control during the installation of these systems means that it is impossible to check whether the insulation material has affected the functioning of the cavity trays.

Lead flashings

In most cases a cavity tray will be required to work in conjunction with a lead flashing at a roof/wall abutment. The cavity tray protects the inside of the outer leaf and the cavity and the lead flashing protects the face of the outer leaf and the junction between the roof covering and the wall.

The lead flashings associated with cavity trays can be dealt with in one of two ways. Either as a factory fitted integral part of the cavity tray or as an independent flashing fitted separately to the cavity tray. When specifying or installing cavity trays and lead flashings it is important to consider the following recommendations:

Leaded cavity trays with factory fitted integral flashings

- In the case of stepped cavity trays it is very important to specify the exact pitch of the roof. The lead flashings are accurately cut to suit the specified pitch and will look aesthetically incorrect if used on any other roof pitch
- All leaded cavity trays are available with a choice of 'long' or 'short' leads and it is important to specify which is preferred. The general rule is that long leads are used where the flashing is required to dress down over the surface of the roof covering and short leads are used in conjunction with a separate soaker or secret gutter detail. It is important to remember that this is just a general rule and many specifiers and end users have their own preferences as to how the flashings should be dressed. Timloc must be informed of any specific requirements

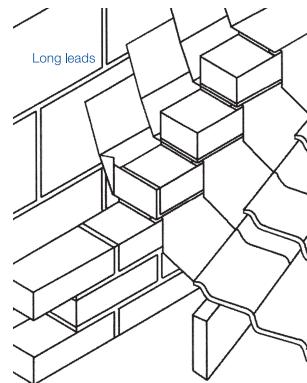
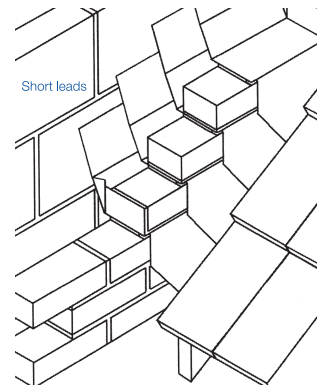



Technical information & installation advice

Page 4 of 5

- Unless otherwise specified by the customer all leaded cavity trays are supplied fitted with Code Blue lead. The specifier or end user should bear in mind that a heavier code of lead may be preferable in situations where severe weather exposure is anticipated in order to withstand wind uplift and provide improved weather performance. It is the customers responsibility to inform Timloc if the building will be subject to severe weather exposure or if a heavier code of lead is preferred
- It is strongly recommended that the laps on the lead flashings are sealed using an exterior grade mastic. This will assist in preventing wind uplift and will reduce the possibility of wind blown rain being driven between the flashings. In areas of very severe weather exposure it is recommended that all flashings are mechanically fixed in order to prevent uplift
- In situations where cavity trays with short leads are to be used it is important that equal attention is paid to the construction and fitting of the soakers or secret gutter. They must include adequate laps and an upstand of at least 75mm against the wall
- High quality workmanship and attention to detail are essential when dressing the lead flashings. Timloc strongly recommend that reference is made to the Lead Sheet Manual published by The Lead Sheet Association

Secondary lead flashings fitted separately to the cavity trays

- As the cavity trays are installed it is important to rake out the mortar below the base of the cavity tray to a depth of 25mm. This is to provide an opening in which to insert the lead flashing. It is preferable to rake out the mortar while it is still green, once the mortar has set it will be difficult to cut a chase for the lead without causing damage to the base of the cavity tray

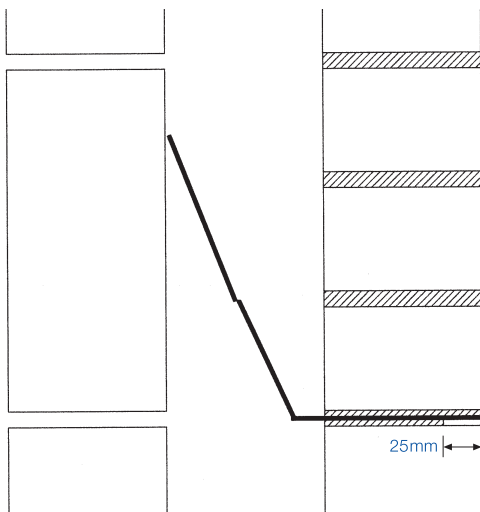

- The lead must be inserted **below** the base of the cavity tray and let into the wall by 25mm. Lead wedges should be used to secure the lead in place and these should be driven in above the base of the cavity tray. This has the effect of forcing the lead and cavity tray together
- The flashings should now be dressed into position according to the flashing detail which is required
- Once the lead has been fitted and dressed into position the mortar joint should be made good. It is preferable if the gap between the lead and cavity tray is sealed using an exterior grade mastic. This will provide a far better weather proof seal than would be achieved if it was simply re-pointed with mortar

- High quality workmanship and attention to detail are essential when fitting and dressing the lead flashings and any associated items such as soakers or secret gutter. Timloc strongly recommends that the weather exposure of the site is considered when selecting the code of lead which is to be used and that reference is made to the Lead Sheet Manual published by The Lead Sheet Association.

Stopends and wall weeps

The fundamental principles of a cavity tray system are that the water which has penetrated the wall must be collected, contained and then discharged back out of the wall. Two items which are vitally important in allowing this to be achieved are stopends and wall weeps:

- Stopends assist in containing the water. They prevent the water from running off the end of the cavity tray and back into the wall. They may take the form of an add-on stopend unit in the case of horizontal cavity trays or a dedicated stopend starter tray in the case of stepped cavity trays. Never specify, order or install cavity trays without the appropriate stopend components
- Wall weeps allow the water which has been collected by the cavity trays to be discharged from the wall. Without wall weeps the majority of the water collected by the cavity trays will remain in the trays. At times of severe weather this could lead to water building up to such a level that the cavity trays can no longer function correctly. Always allow for wall weeps to be included in every stopend starter tray and to be spaced at 900mm centres along the full length of any horizontal cavity tray ensuring one weep per Inter-loc tray.

Lintels

Lintels over external windows and door openings usually require cavity tray protection. The requirement for a cavity tray will be on the request of the lintel manufacturer and/or the construction designer.

Timloc offer a comprehensive range of preformed cavity trays for lintel protection with profile options to suit most lintel manufacturers.

- As with any type of cavity tray the lintel tray should be bedded onto fresh mortar and not dry bedded. The final effect should be that the cavity tray is positioned approximately half way through the horizontal mortar joint
- The cavity lintel tray should at least cover the full length of the lintel. Ideally the cavity tray should project slightly beyond the lintel at both ends and must project at least 150mm beyond the sides of the door or window opening
- Stopends and wall weeps are essential if the lintel cavity tray is to function correctly (see previous section)
- Purpose made lintel stopends are manufactured by Timloc and are shaped to suit the profile of popular makes and sizes of steel lintel. These stopends are supplied complete with a factory fitted butyl mastic strip for sealing them onto the lintel or lintel DPC. For this butyl mastic strip to seal correctly it is essential that the release paper is removed, the joint area is clean and dry and firm pressure is applied along the full length of the joint area
- Wall weeps must be positioned along the front flange of the lintel spaced at approximately 450mm centres. There must be at least two wall weeps per lintel, even if the lintel is very short
- During construction make sure that the cavity area is kept clean and free from mortar droppings and other debris. A build up of mortar on the lintel cavity tray could adversely affect its performance



Technical information & installation advice

Structural implications

When cavity trays or DPC's are correctly installed the ability of a wall to sustain and transmit compressive loads will not be adversely affected.

The presence of any kind of cavity tray or DPC can reduce the tensile strength of a wall at that point and the building designer may need to take this into account.

Product selection and calculation of quantities

Timloc recommend that customers take advantage of the Technical Advisory Service which is freely available to all users and specifiers of Timloc products. The Technical Services Department will be pleased to advise on the most suitable products to meet the application and will prepare a fully itemised schedule of quantities. Please provide as much information as possible, including drawings if they are available. All enquiries should include the following information as a minimum requirement:

- The materials used for construction of the outer leaf, i.e. brick, block or stone, including the bed thickness and course height
- The overall structural cavity width within the wall
- The type and thickness of any insulation material used within the wall cavity
- The pitch of the roof (in the case of pitched roof abutments)
- The type of roof covering or state whether long or short leads are required (in the case of leaded cavity trays)
- Clear dimensional information or accurate scale drawings relevant to the areas requiring cavity trays
- Comments with regard to the weather exposure of the site
- Any specific or non-standard requirements are to be clearly stated.

Calculating quantities of cavity trays

Stepped cavity trays

Stepped cavity trays are used where a pitched roof abuts a cavity wall. To calculate the quantity of trays required to cover a section of roof abutment one of three measurements must be determined, either the vertical height or the sloping or horizontal length of the abutment. If the vertical height is measured, simply divide this distance by the coursing height of the material being used for construction.

E.g. If the vertical height is 1.5m and the wall is standard 75mm brick coursing (NB 75mm = 0.075m) the equation would be $1.5 \div 0.075 = 20$. Therefore 20 No. cavity trays are required per sloping abutment.

If the sloping or horizontal distance has been measured the tables shown below should be used to convert the distance (measured in metres) into the quantity of cavity trays. Take care to select the correct table and the appropriate column which relates to the coursing height and the pitch of the abutting roof.

E.g. If the sloping measurement is 2.5m, at a pitch of 30°, with a 75mm brick coursing height the equation would be $2.5 \times 6.7 = 16.75$. This would be rounded up, so 17 No. cavity trays are required.

E.g. If the horizontal measurement is 1.5m, at a pitch of 40°, with a 150mm stone coursing height the equation would be $1.5 \times 5.6 = 8.4$. This would be rounded down, so 8 No. cavity trays are required.

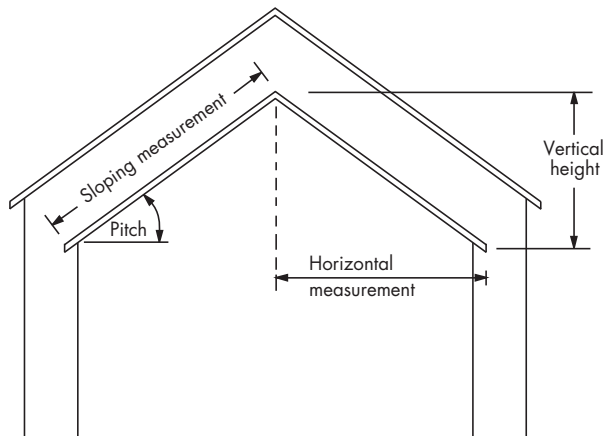

Stepped cavity trays sloping measurement

Roof pitch	Coursing height			
	75mm brick	150mm stone	200mm block	225mm block
10°	2.3	1.2	0.9	0.8
12.5°	2.9	1.4	1.1	1.0
15°	3.5	1.7	1.3	1.2
17.5°	4.0	2.0	1.5	1.3
20°	4.6	2.3	1.7	1.5
22.5°	5.1	2.6	1.9	1.7
25°	5.6	2.8	2.1	1.9
27.5°	6.2	3.1	2.3	2.1
30°	6.7	3.3	2.5	2.2
32.5°	7.2	3.6	2.7	2.4
35°	7.7	3.8	2.9	2.6
37.5°	8.1	4.1	3.0	2.7
40°	8.6	4.3	3.2	2.9
42.5°	9.0	4.5	3.4	3.0
45°	9.4	4.7	3.5	3.1

Stepped cavity trays horizontal measurement

Roof pitch	Coursing height			
	75mm brick	150mm stone	200mm block	225mm block
10°	2.4	1.2	0.9	0.8
12.5°	3.0	1.5	1.1	1.0
15°	3.6	1.8	1.3	1.2
17.5°	4.2	2.1	1.6	1.4
20°	4.9	2.4	1.8	1.6
22.5°	5.5	2.8	2.1	1.8
25°	6.2	3.1	2.3	2.1
27.5°	7.0	3.5	2.6	2.3
30°	7.7	3.9	2.9	2.6
32.5°	8.5	4.3	3.2	2.8
35°	9.3	4.7	3.5	3.1
37.5°	10.2	5.1	3.8	3.4
40°	11.2	5.6	4.2	3.7
42.5°	12.2	6.1	4.6	4.1
45°	13.3	6.7	5.0	4.4

Horizontal cavity trays

Calculating the quantity of horizontal cavity trays required is reasonably straightforward. Simply measure the overall width of the abutting roof, or width of the area where cavity tray protection is required, and divide this measurement by the effective length of the cavity tray component which you have chosen to use.

E.g. If you have an abutment 2.5m in width and you are using a 2005E horizontal tray, divide 2.5m by the effective length of the tray, which in this case is 440mm or 0.44m. This gives an answer of 5.68, which would be rounded up to 6 No.