

Ducting To Airbrick Adapter Sets (Product Codes: 3500 and 3510)

Please read these instructions carefully before starting work.
We recommend that installation and preparations are carried out by a suitable tradesperson.

ASSEMBLED
SETS READY FOR
**IMMEDIATE
INSTALLATION**

Use

Assembled ducting to airbrick adapter sets to terminate rigid extraction ductwork at a standard airbrick (supplied).

Application for through:

- Floor level voids
- External walls
- Relevent for working temperatures of -20 to 60 °C

Suitable for rigid extraction ductwork from:

- Bathrooms
- WC cloakrooms
- Utility rooms

3500 - Round ducting to airbrick adapter set

Suitable for 100mm diameter round rigid ducting

Assembled set contains:

- 9x3" (215 x 69mm) plastic airbrick
- Slotted airbrick connector
- Circular duct tube (100mm dia x 150mm)
- Circular duct adapter (140mm x 100mm dia)

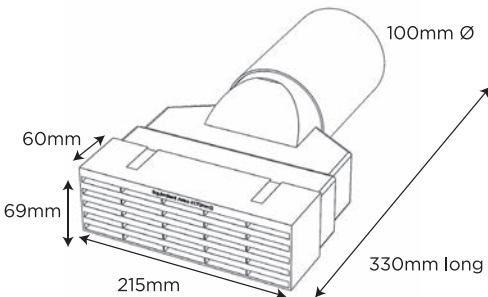

3510 - Rectangular ducting to airbrick adapter set

Suitable for 110 x 54mm rectangular rigid ducting.

Assembled set contains:

- 9x3" (215 x 69mm) plastic airbrick
- Slotted airbrick connector
- Rectangular duct profile - (110W x 54H x 390L mm)

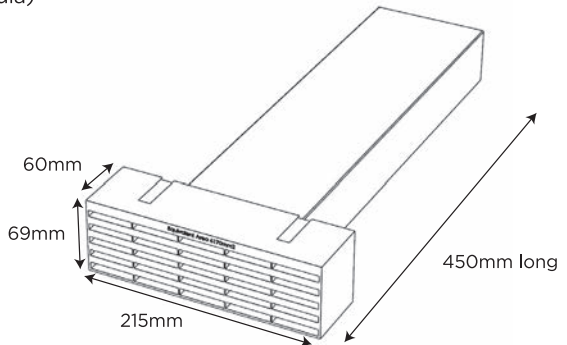

(*Airbrick colour codes: terracotta = TE, buff = BU, brown = BR, grey = GR, black = BL and white = WH)

For further assistance:

T: 01405 765 567 E: technical@timloc.co.uk
W: www.timloc.co.uk



A UK
MANUFACTURER

1. Build in the Ducting to Airbrick Adapter Set as brickwork and blockwork proceeds.

- a. The position and level to be determined by the extraction fan connections.
- b. The plastic airbrick will replace a regular brick.

3500

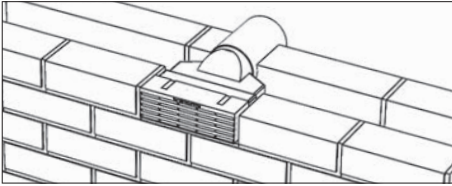

3510

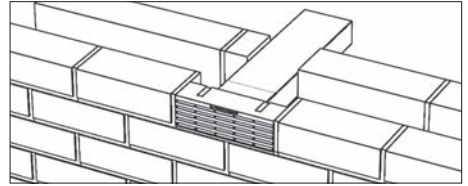

2. Bed the plastic airbrick on an even and level mortar bed.

- a. Fill in all the surrounding joints, as normal brickwork.
- b. Position the plastic airbrick flush with the external brickwork face.

3500

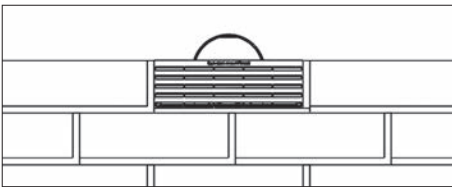

3510

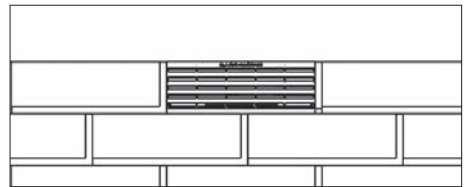

3. The adapter set will project beyond the inner wall leaf to allow for the fitting of additional ducting or a direct installation of an extraction fan.

- a. Excess ducting can be cut away if required using a basic hacksaw or saw.

3500

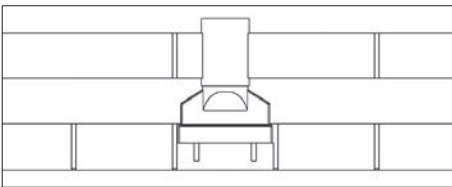

3510

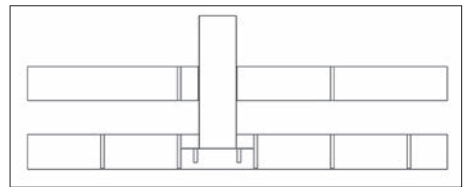

(Ariel view of installed units)

For further assistance:

T: 01405 765 567 E: technical@timloc.co.uk
W: www.timloc.co.uk

4. Cut the inner blockwork as work proceeds to accept the rear ducting.

- a. Point all cut blockwork around adapter set to reduce air leakage opportunities.
- b. The protruding rear ducting will allow for further connections.

3500

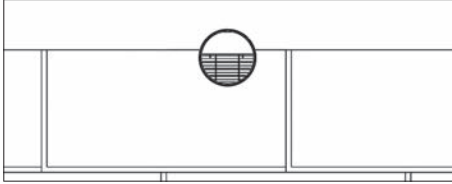

(Internal view of installed units)

3510

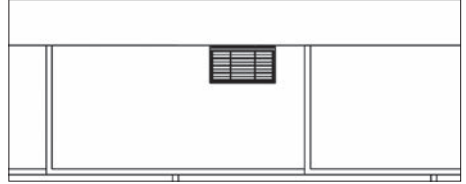

5. Install a DPC cavity tray directly above the Ducting to Airbrick Adapter Set as work proceeds, to collect any water ingress from above (recommended practice for any through cavity wall components).

- a. The cavity tray must have stop ends fitted.
- b. The cavity tray must project into the cavity to collect any water ingress.
- c. Ensure that the cavity tray is bedded onto wet mortar.
- d. Insert 2 proprietary wall weeps into the cavity tray to allow water drainage.
- e. Position the weeps directly above both sides of the airbrick.

We recommend Timloc Building Products':

- Inter-loc 4 brick horizontal cavity tray (with intergrated stop ends) - product code IL4
- Wall weep product codes:
 - **TW1 + colour*** - Concealed Tunnel Weep or;
 - **1143 + colour*** - Wall Weep Vent.

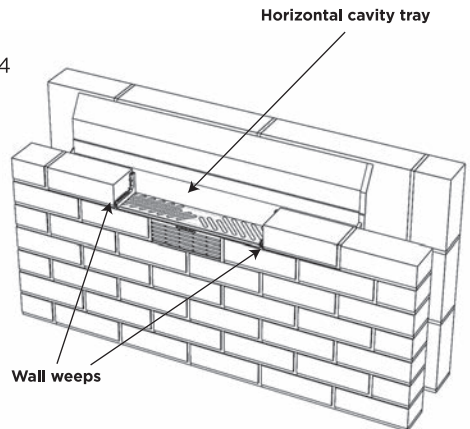
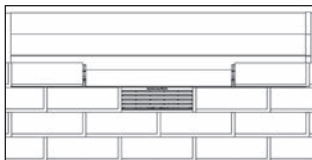

* Colours: terracotta, buff, brown, grey, black, white and clear.

For further assistance:

T: 01405 765 567 **E:** technical@timloc.co.uk
W: www.timloc.co.uk

6. Continue and complete the brickwork with the Ducting to Airbrick Adapter Set in position.

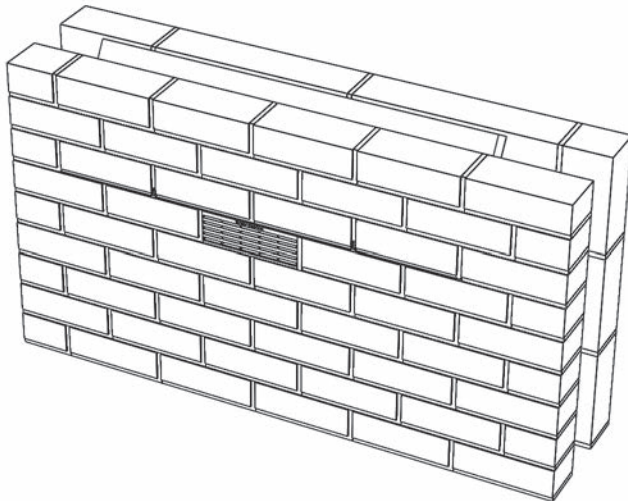

Cavity trays



Access panels



Loft access doors



Gas barrier and damp proofing accessories



Under floor and through wall ventilation



Roof ventilation



Cavity closers



Air leakage solutions

Timloc Building Products do not accept responsibility for errors or misinterpretation of information. The customer should satisfy themselves that the products are suitable for the intended purpose.

Following its policy of continuing product improvement, Timloc Building Products reserves the right to introduce changes to the specification and modification of design at any time without due notice.

